

ENGINE

Model	Yanmar 3TNV88F-E
Emissions Certification	Tier 4 Final
Cylinders	3
Displacement	100 in ³ (1.6 L)
Fuel injection	Mechanical w/ electronic governor
Fuel injection pump	Direct
Fuel	Diesel
Cooling	Water-cooled
Net horsepower – SAE J1349 @ 2400 RPM:	23.1 hp (17.2 kW)

DRIVETRAIN

Travel speeds:	
1st	1.6 mph (2.5 kph)
2nd	2.7 mph (4.4 kph)
Gradeability	30°
Drawbar pull	8,655 lb (38.5 kN)

ELECTRICAL

Voltage	12 Volts
Alternator rating	24 amp
Battery	12-volt low-maintenance

OPERATOR ENVIRONMENT

ROPS/FOPS three post canopy; Pilot operated hand controls and foot pedals; Adjustable seat w/ seat belt; Arm rests.

Display includes:

Engine oil pressure; Water temperature lamp; Low fuel warning lamp; Battery charge lamp; Water temperature gauge; Fuel gauge and hour meter.

OPERATING WEIGHT

Cab operating weight	8,554 lb (3 880 kg)
w/ counterweight	+551 lb (250 kg)
Canopy operating weight	8,212 lb (3 725 kg)
w/ counterweight	+551 lb (250 kg)

NOTE: w/ operator/full fuel/standard equipment.

HYDRAULICS

Main pumps	Tandem variable displacement/ axial piston pump	
Max. rated flow	2 x 10.1 gpm (2 x 38.4 L/min)	
Auxiliary flow	15.2 gpm (57.6 L/min)	
System relief pressure:		
Standard	3,336 psi (230 bar)	
Pilot control hydraulic system:		
Pump	Gear pump	
Maximum capacity	2.9 gpm (10.8 L/min)	
Relief pressure	508 psi (35 bar)	
Control valves		
Pilot control for left/right track travel, boom, arm, bucket and swing.	Manual control for breaker and backfill blade.	
Swing/Dozer blade:		
Motor	Fixed displaced axial piston	
Travel:		
Motors – 2	Two-speed axial piston	
Final drive	Planetary gear reduction	

SERVICE CAPACITIES

Fuel tank	11 gal (42 L)
Hydraulic tank:	
Refill capacity	5.4 gal (20.4 L)
Total system	11.8 gal (44.8 L)
Engine w/ filter change	1.5 gal (5.5 L)
Radiator	1.2 gal (4.6 L)

OTHER SPECIFICATIONS

Swing speed	0 – 8.4 RPM
Swing brake	Spring applied, hydraulically released w/ dual cushion relief
Undercarriage:	
Top tracks – each	1 roller
Bottom tracks – each	4 rollers
Boom:	
Swing	70° left/60° right
Length	8 ft 2 in (2.49 m)
Arm:	
Length	4 ft 4 in (1 320 mm)

LIFT CAPACITIES

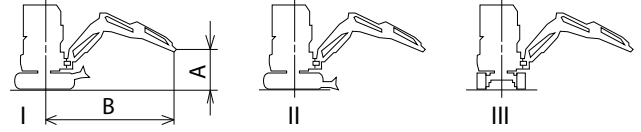

Cab model without ACW — 4 ft 6 in (1.4 m) Arm

Lift capacities calculated using 11.8 in (300 mm) shoes, without bucket, blade up/down.

A \ B	5 ft (1.5 m)		7.5 ft (2.3 m)		10 ft (3.0 m)		12.5 ft (3.8 m)		15 ft (4.6 m)		MAXIMUM REACH		
	I II	III	I II	III	I II	III	I II	III	I II	III	@	I II	III
+12.5 ft (3.8 m)											11 ft 6 in (3.52 m)	1,600 lb (720 kg) 1,820 lb* (820 kg)*	1,510 lb (680 kg)
+10 ft (3.0 m)							1,420 lb (640 kg) 1,730 lb* (780 kg)*	1,340 lb (600 kg)			13 ft 6 in (4.12 m)	1,240 lb (560 kg) 1,790 lb* (810 kg)*	1,160 lb (520 kg)
+7.5 ft (2.3 m)					1,980 lb (890 kg) 2,040 lb* (920 kg)*	1,850 lb (830 kg)	1,390 lb (630 kg) 1,850 lb* (830 kg)*	1,310 lb (590 kg)			14 ft 7 in (4.46 m)	1,070 lb (480 kg) 1,810 lb* (820 kg)*	1,010 lb (450 kg)
+5 ft (1.5 m)			2,900 lb (1 310 kg) 4,190 lb* (1 900 kg)*	2,660 lb (1 200 kg)	1,870 lb (840 kg) 2,630 lb* (1 190 kg)*	1,750 lb (790 kg)	1,340 lb (600 kg) 2,090 lb* (940 kg)*	1,260 lb (570 kg)	1,010 lb (450 kg) 1,860 lb* (840 kg)*	960 lb (430 kg)	15 ft 1 in (4.62 m)	1,000 lb (450 kg) 1,850 lb* (830 kg)*	940 lb (420 kg)
+2.5 ft (0.8 m)			2,720 lb (1 230 kg) 3,780 lb* (1 710 kg)*	2,490 lb (1 120 kg)	1,780 lb (800 kg) 3,140 lb* (1 420 kg)*	1,660 lb (750 kg)	1,290 lb (580 kg) 2,330 lb* (1 050 kg)*	1,210 lb (540 kg)	1,000 lb (440 kg) 1,920 lb* (870 kg)*	940 lb (420 kg)	15 ft 1 in (4.62 m)	980 lb (440 kg) 1,900 lb* (860 kg)*	920 lb (410 kg)
Ground Level			2,690 lb (1 220 kg) 5,230 lb* (2 370 kg)*	2,460 lb (1 110 kg)	1,730 lb (780 kg) 3,360 lb* (1 520 kg)*	1,610 lb (730 kg)	1,260 lb (570 kg) 2,460 lb* (1 110 kg)*	1,180 lb (530 kg)			14 ft 7 in (4.45 m)	1,020 lb (460 kg) 1,970 lb* (890 kg)*	960 lb (430 kg)
-2.5 ft (-0.8 m)	4,860 lb* (2 200 kg)* 4,860 lb* (2 200 kg)*	4,860 lb* (2 200 kg)*	2,700 lb (1 220 kg) 4,830 lb* (2 190 kg)*	2,470 lb (1 120 kg)	1,720 lb (780 kg) 3,250 lb* (1 470 kg)*	1,600 lb (720 kg)	1,260 lb (570 kg) 2,350 lb* (1 060 kg)*	1,180 lb (530 kg)			13 ft 5 in (4.11 m)	1,140 lb (510 kg) 2,030 lb* (920 kg)*	1,070 lb (480 kg)
-5 ft (-1.5 m)	6,100 lb (2 760 kg) 6,720 lb* (3 040 kg)*	5,290 lb (2 390 kg)	2,750 lb (1 240 kg) 3,940 lb* (1 780 kg)*	2,520 lb (1 140 kg)	1,760 lb (790 kg) 2,690 lb* (1 220 kg)*	1,630 lb (730 kg)					11 ft 6 in (3.50 m)	1,450 lb (650 kg) 2,060 lb* (930 kg)*	1,360 lb (610 kg)
-7.5 ft (-2.3 m)			1,840 lb* (830 kg)* 1,840 lb* (830 kg)*	1,840 lb* (830 kg)*							7 ft 8 in (2.35 m)	1,740 lb* (780 kg)* 1,740 lb* (780 kg)*	1,740 lb* (780 kg)*

Lift capacities marked with an asterisk () are limited by 87% hydraulic capacity.

Cab model with ACW — 4 ft 6 in (1.4 m) Arm

Lift capacities calculated using 11.8 in (300 mm) shoes, without bucket, blade up/down, counterweight +551 lb (+250 kg) Add-on.

A \ B	5 ft (1.5 m)		7.5 ft (2.3 m)		10 ft (3.0 m)		12.5 ft (3.8 m)		15 ft (4.6 m)		MAXIMUM REACH		
	I II	III	I II	III	I II	III	I II	III	I II	III	@	I II	III
+12.5 ft (3.8 m)											11 ft 6 in (3.52 m)	1,820 lb* (820 kg)* 1,820 lb* (820 kg)*	1,750 lb (790 kg)
+10 ft (3.0 m)								1,560 lb (700 kg)			13 ft 6 in (4.12 m)	1,450 lb (650 kg) 1,790 lb* (810 kg)*	1,360 lb (610 kg)
+7.5 ft (2.3 m)						2,040 lb* (920 kg)*	1,650 lb (740 kg) 1,730 lb* (780 kg)*	1,530 lb (690 kg)			14 ft 7 in (4.46 m)	1,270 lb (570 kg) 1,810 lb* (820 kg)*	1,190 lb (530 kg)
+5 ft (1.5 m)			3,390 lb (1 530 kg) 4,190 lb* (1 900 kg)*	3,100 lb (1 400 kg)	2,040 lb* (920 kg)* 2,040 lb (920 kg)	2,040 lb (920 kg)	1,630 lb (730 kg) 1,850 lb* (830 kg)*	1,480 lb (670 kg)	1,200 lb (540 kg) 1,860 lb* (840 kg)*	1,130 lb (510 kg)	15 ft 1 in (4.62 m)	1,180 lb (530 kg) 1,850 lb* (830 kg)*	1,110 lb (500 kg)
+2.5 ft (0.8 m)			3,210 lb (1 450 kg) 3,780 lb* (1 710 kg)*	2,930 lb (1 320 kg)	2,190 lb (990 kg) 2,630 lb* (1 190 kg)*	1,950 lb (880 kg)	1,580 lb (710 kg) 2,090 lb* (940 kg)*	1,430 lb (640 kg)	1,180 lb (530 kg) 1,920 lb* (870 kg)*	1,110 lb (500 kg)	15 ft 1 in (4.62 m)	1,170 lb (530 kg) 1,900 lb* (860 kg)*	1,100 lb (490 kg)
Ground Level			3,170 lb (1 430 kg) 5,230 lb* (2 370 kg)*	2,900 lb (1 310 kg)	2,100 lb (950 kg) 3,140 lb* (1 420 kg)*	1,900 lb (860 kg)	1,530 lb (690 kg) 2,330 lb* (1 050 kg)*	1,400 lb (630 kg)			14 ft 7 in (4.45 m)	1,210 lb (540 kg) 1,970 lb* (890 kg)*	1,140 lb (510 kg)
-2.5 ft (-0.8 m)	4,860 lb* (2 200 kg)* 4,860 lb* (2 200 kg)*	4,860 lb* (2 200 kg)*	3,190 lb (1 440 kg) 4,830 lb* (2 190 kg)*	2,910 lb (1 310 kg)	2,050 lb (920 kg) 3,360 lb* (1 520 kg)*	1,900 lb (860 kg)	1,500 lb (680 kg) 2,460 lb* (1 110 kg)*	1,400 lb (630 kg)			13 ft 5 in (4.11 m)	1,360 lb (610 kg) 2,030 lb* (920 kg)*	1,270 lb (570 kg)
-5 ft (-1.5 m)	6,720 lb* (3 040 kg)* 6,720 lb* (3 040 kg)*	6,180 lb (2 800 kg)	3,240 lb (1 460 kg) 3,940 lb* (1 780 kg)*	2,960 lb (1 340 kg)	2,040 lb (920 kg) 3,250 lb* (1 470 kg)*	1,930 lb (870 kg)	1,500 lb (680 kg) 2,350 lb* (1 060 kg)*				11 ft 6 in (3.50 m)	1,710 lb (770 kg) 2,060 lb* (930 kg)*	1,600 lb (720 kg)
-7.5 ft (-2.3 m)			1,840 lb* (830 kg)* 1,840 lb* (830 kg)*	1,840 lb* (830 kg)*	2,070 lb (930 kg) 2,690 lb* (1 220 kg)*						7 ft 8 in (2.35 m)	1,740 lb* (780 kg)* 1,740 lb* (780 kg)*	1,740 lb* (780 kg)*

Lift capacities marked with an asterisk () are limited by 87% hydraulic capacity.

LIFT CAPACITIES

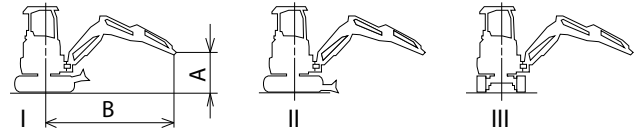

Canopy model without ACW — 4 ft 6 in (1.4 m) Arm

Lift capacities calculated using 11.8 in (300 mm) shoes, without bucket, blade up/down.

A \ B	5 ft (1.5 m)		7.5 ft (2.3 m)		10 ft (3.0 m)		12.5 ft (3.8 m)		15 ft (4.6 m)		@	MAXIMUM REACH		
	I II	III	I II	III	I II	III	I II	III	I II	III		I II	III	
+12.5 ft (3.8 m)											11 ft 6 in (3.52 m)	1,530 lb (690 kg) 1,820 lb* (820 kg)*	1,450 lb (650 kg)	
+10 ft (3.0 m)							1,350 lb (610 kg) 1,730 lb* (780 kg)*	1,280 lb (580 kg)			13 ft 6 in (4.12 m)	1,180 lb (530 kg) 1,790 lb* (810 kg)*	1,110 lb (500 kg)	
+7.5 ft (2.3 m)					1,900 lb (860 kg) 2,040 lb* (920 kg)*	1,780 lb (800 kg)	1,330 lb (600 kg) 1,850 lb* (830 kg)*	1,250 lb (560 kg)			14 ft 7 in (4.46 m)	1,020 lb (460 kg) 1,810 lb* (820 kg)*	970 lb (430 kg)	
+5 ft (1.5 m)			2,770 lb (1 250 kg) 4,190 lb* (1 900 kg)*	2,550 lb (1 150 kg)	1,790 lb (810 kg) 2,630 lb* (1 190 kg)*	1,670 lb (750 kg)	1,280 lb (580 kg) 2,090 lb* (940 kg)*	1,210 lb (540 kg)	960 lb (430 kg)	910 lb (410 kg)	15 ft 1 in (4.62 m)	1,860 lb* (840 kg)*	950 lb (430 kg) 1,850 lb* (830 kg)*	900 lb (400 kg)
+2.5 ft (0.8 m)			2,590 lb (1 170 kg) 3,780 lb* (1 710 kg)*	2,380 lb (1 070 kg)	1,690 lb (760 kg) 3,140 lb* (1 420 kg)*	1,580 lb (710 kg)	1,230 lb (550 kg) 2,330 lb* (1 050 kg)*	1,160 lb (520 kg)	950 lb (430 kg)	890 lb (400 kg)	15 ft 1 in (4.62 m)	1,920 lb* (870 kg)*	930 lb (420 kg) 1,900 lb* (860 kg)*	880 lb (390 kg)
Ground Level			2,560 lb (1 160 kg) 5,230 lb* (2 370 kg)*	2,350 lb (1 060 kg)	1,650 lb (740 kg) 3,360 lb* (1 520 kg)*	1,540 lb (690 kg)	1,200 lb (540 kg) 2,460 lb* (1 110 kg)*	1,130 lb (510 kg)			14 ft 7 in (4.45 m)	1,650 lb* (740 kg)*	970 lb (430 kg) 1,970 lb* (890 kg)*	920 lb (410 kg)
-2.5 ft (-0.8 m)	4,860 lb* (2 200 kg)* 4,860 lb* (2 200 kg)*	4,860 lb* (2 200 kg)*	2,570 lb (1 160 kg) 4,830 lb* (2 190 kg)*	2,360 lb (1 070 kg)	1,640 lb (740 kg) 3,250 lb* (1 470 kg)*	1,530 lb (690 kg)	1,200 lb (540 kg) 2,350 lb* (1 060 kg)*	1,130 lb (510 kg)			13 ft 5 in (4.11 m)	1,090 lb (490 kg) 2,030 lb* (920 kg)*	1,020 lb (460 kg)	
-5 ft (-1.5 m)	5,820 lb (2 630 kg) 6,720 lb* (3 040 kg)*	5,070 lb (2 290 kg)	2,620 lb (1 180 kg) 3,940 lb* (1 780 kg)*	2,410 lb (1 090 kg)	1,670 lb (750 kg) 2,690 lb* (1 220 kg)*	1,560 lb (700 kg)					11 ft 6 in (3.50 m)	1,380 lb (620 kg) 2,060 lb* (930 kg)*	1,300 lb (580 kg)	
-7.5 ft (-2.3 m)			1,840 lb* (830 kg)* 1,840 lb* (830 kg)*	1,840 lb* (830 kg)*							7 ft 8 in (2.35 m)	1,740 lb* (780 kg)* 1,740 lb* (780 kg)*	1,740 lb* (780 kg)*	

Lift capacities marked with an asterisk () are limited by 87% hydraulic capacity.

Canopy model with ACW — 4 ft 6 in (1.4 m) Arm

Lift capacities calculated using 11.8 in (300 mm) shoes, without bucket, blade up/down, counterweight +551 lb (+250 kg) Add-on.

A \ B	5 ft (1.5 m)		7.5 ft (2.3 m)		10 ft (3.0 m)		12.5 ft (3.8 m)		15 ft (4.6 m)		@	MAXIMUM REACH		
	I II	III	I II	III	I II	III	I II	III	I II	III		I II	III	
+12.5 ft (3.8 m)											11 ft 6 in (3.52 m)	1,790 lb (810 kg) 1,820 lb* (820 kg)*	1,690 lb (760 kg)	
+10 ft (3.0 m)							1,590 lb (720 kg) 1,730 lb* (780 kg)*	1,500 lb (680 kg)			13 ft 6 in (4.12 m)	1,390 lb (630 kg) 1,790 lb* (810 kg)*	1,310 lb (590 kg)	
+7.5 ft (2.3 m)					2,040 lb* (920 kg)* 2,040 lb* (920 kg)*	2,040 lb* (920 kg)*	1,560 lb (700 kg) 1,850 lb* (830 kg)*	1,470 lb (660 kg)			14 ft 7 in (4.46 m)	1,210 lb (540 kg) 1,810 lb* (820 kg)*	1,150 lb (520 kg)	
+5 ft (1.5 m)			3,260 lb (1 470 kg) 4,190 lb* (1 900 kg)*	2,990 lb (1 350 kg)	2,110 lb (950 kg) 2,630 lb* (1 190 kg)*	1,970 lb (890 kg)	1,510 lb (680 kg) 2,090 lb* (940 kg)*	1,430 lb (640 kg)	1,150 lb (520 kg)	1,090 lb (490 kg)	15 ft 1 in (4.62 m)	1,860 lb* (840 kg)*	1,130 lb (510 kg) 1,850 lb* (830 kg)*	1,070 lb (480 kg)
+2.5 ft (0.8 m)			3,080 lb (1 390 kg) 3,780 lb* (1 710 kg)*	2,820 lb (1 270 kg)	2,010 lb (910 kg) 3,140 lb* (1 420 kg)*	1,880 lb (850 kg)	1,470 lb (660 kg) 2,330 lb* (1 050 kg)*	1,380 lb (620 kg)	1,130 lb (510 kg)	1,070 lb (480 kg)	15 ft 1 in (4.62 m)	1,920 lb* (870 kg)*	1,120 lb (500 kg) 1,900 lb* (860 kg)*	1,050 lb (470 kg)
Ground Level			3,040 lb (1 370 kg) 5,230 lb* (2 370 kg)*	2,790 lb (1 260 kg)	1,960 lb (880 kg) 3,360 lb* (1 520 kg)*	1,830 lb (830 kg)	1,440 lb (650 kg) 2,460 lb* (1 110 kg)*	1,350 lb (610 kg)			14 ft 7 in (4.45 m)	1,650 lb* (740 kg)*	1,160 lb (520 kg) 1,970 lb* (890 kg)*	1,100 lb (490 kg)
-2.5 ft (-0.8 m)	4,860 lb* (2 200 kg)* 4,860 lb* (2 200 kg)*	4,860 lb* (2 200 kg)*	3,060 lb (1 380 kg) 4,830 lb* (2 190 kg)*	2,800 lb (1 270 kg)	1,960 lb (880 kg) 3,250 lb* (1 470 kg)*	1,820 lb (820 kg)	1,430 lb (640 kg) 2,350 lb* (1 060 kg)*	1,350 lb (610 kg)			13 ft 5 in (4.11 m)	1,300 lb (580 kg) 2,030 lb* (920 kg)*	1,220 lb (550 kg)	
-5 ft (-1.5 m)	6,720 lb* (3 040 kg)* 6,720 lb* (3 040 kg)*	5,960 lb (2 700 kg)	3,110 lb (1 410 kg) 3,940 lb* (1 780 kg)*	2,850 lb (1 290 kg)	1,990 lb (900 kg) 2,690 lb* (1 220 kg)*	1,850 lb (830 kg)					11 ft 6 in (3.50 m)	1,640 lb (740 kg) 2,060 lb* (930 kg)*	1,540 lb (690 kg)	
-7.5 ft (-2.3 m)			1,840 lb* (830 kg)* 1,840 lb* (830 kg)*	1,840 lb* (830 kg)*							7 ft 8 in (2.35 m)	1,740 lb* (780 kg)* 1,740 lb* (780 kg)*	1,740 lb* (780 kg)*	

Lift capacities marked with an asterisk () are limited by 87% hydraulic capacity.

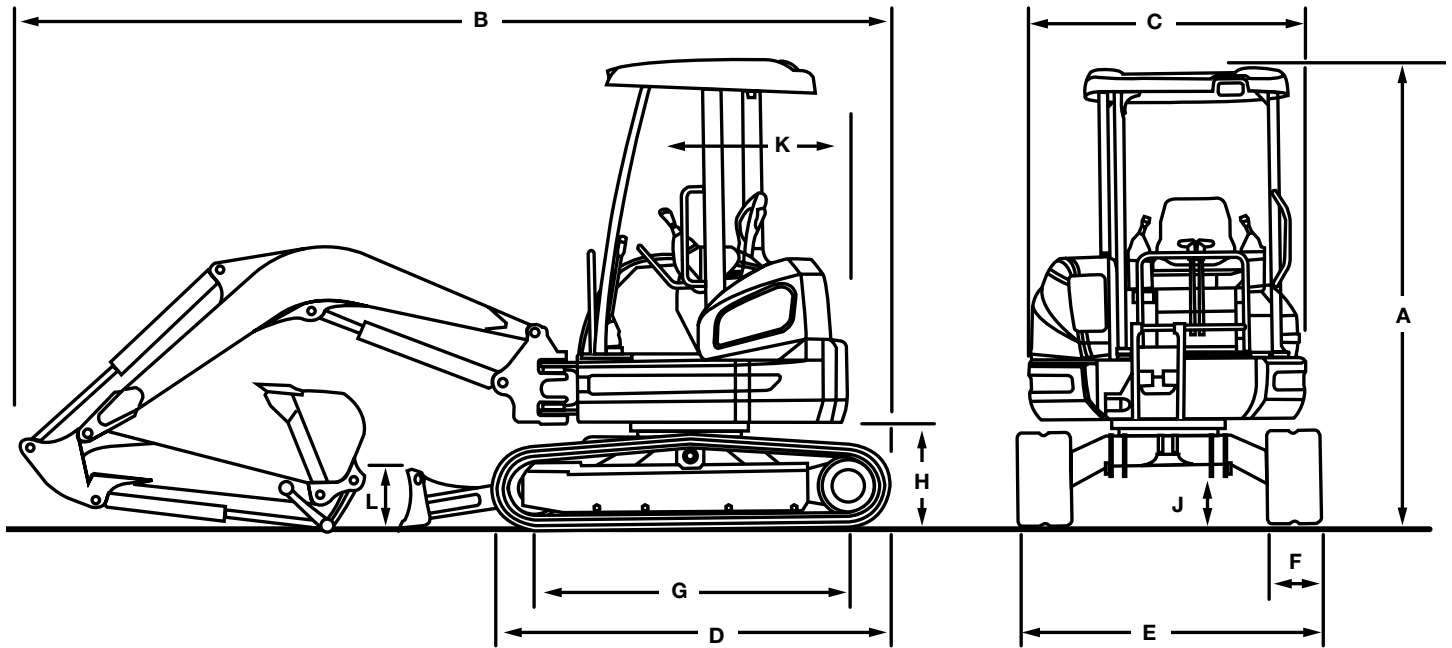

Line drawings are for illustrative purpose only and may not be exact representation of unit.

DIMENSIONS

A. Overall height	8 ft 3 in (2 510 mm)
B. Overall length	15 ft 10 in (4 820 mm)
C. Width of upper structure	5 ft 0 in (1 530 mm)
D. Track overall length	7 ft 1 in (2 160 mm)
E. Track overall width with 11.8 in (300 mm) shoes	5 ft 7 in (1 700 mm)
F. Track shoe width	11.8 in (300 mm)
G. Center to center – idler to sprocket	5 ft 7 in (1 700 mm)
H. Upper structure ground clearance	1 ft 10 in (570 mm)
J. Minimum ground clearance	11.8 in (300 mm)
K. Tail swing radius	2 ft 10 in (850 mm)
L. Backfill blade height	1 ft 2 in (345 mm)
Working weight	8,554 lb (3 880 kg)
Ground pressure	4.7 psi (32.4 kPa)
Boom swing	70° left/60° right
Tail swing overhang	0 ft 0 in (0 mm)

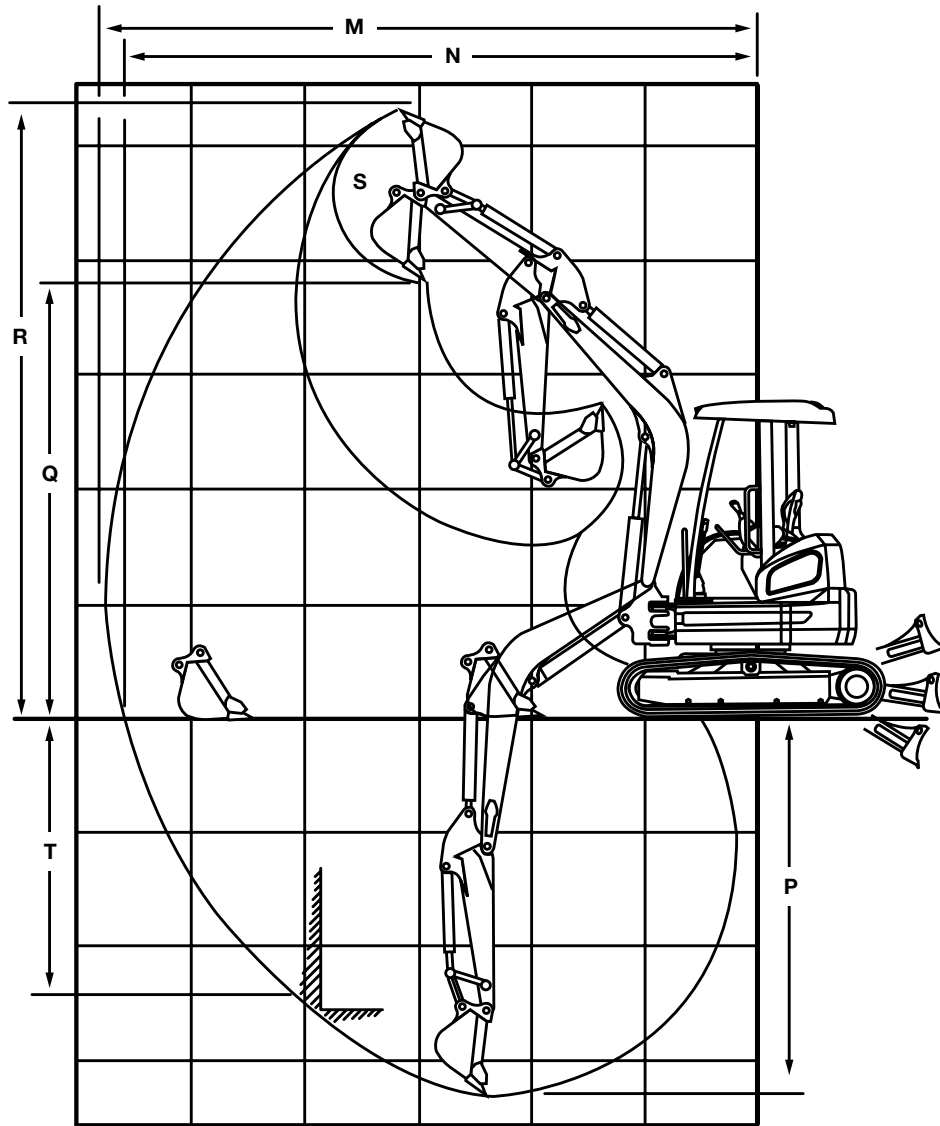

Line drawings are for illustrative purpose only and may not be exact representation of unit.

PERFORMANCE SPECS

	4 ft 6 in (1.37 m) Arm
M. Maximum dig radius	17 ft 7 in (5 350 mm)
N. Dig radius at groundline	17 ft 1 in (5 200 mm)
P. Maximum dig depth	10 ft 0 in (3 050 mm)
Q. Dump height	11 ft 5 in (3 490 mm)
R. Overall reach height	16 ft 0 in (4 870 mm)
S. Bucket rotation	178°
T. Vertical straight wall dig depth	8 ft 1 in (2 470 mm)
Arm digging force	5,036 lb (22.4 kN)
Bucket digging force: 2 position bucket	6,227 lb (27.7 kN)

STANDARD EQUIPMENT

OPERATOR ENVIRONMENT

See page 1

ENGINE

Yanmar 3TNV88F-E diesel
4 Cycle
Water cooled
Direct injection
One touch decelerator
Engine access under rear hood
Dry type air cleaner with restriction indicator
Glow plug starting aid

ELECTRICAL

12-volt electrical starting system
Heavy-duty battery
Horn

HYDRAULICS

Auxiliary hydraulics – single/bi-directional –
and plumbing to arm
Large hydraulic oil cooler
Control pattern selector valve

TRACK DRIVE

Rubber tracks
Automatic 2-speed travel
Fully hydrostatic drive system
Sealed and lubricated track rollers
Track tension adjustment – grease type
Disc type parking brake – auto release and apply

UPPER STRUCTURE

Zero tail swing
Swing lock
Swing brake
Swing shock valve

OTHER

Swing boom – 70° left/60° right
Hydraulic backfill blade

OPTIONAL EQUIPMENT

OPERATOR ENVIRONMENT

Cab enclosure with heater and AC
Radio
Operator front guard
Rearview mirror
Rear under mirror
LCD Monitor

OTHER

Steel tracks
5 ft 3 in (1.59 m) arm
Mechanical coupler
Travel alarm
Additional counterweight
Arm/bucket cylinder rod cover
Air filter double element
4-way backfill blade
Rotating beacon
Thumb cylinder bracket – Standard arm only

BUCKETS

Width	SAE Heaped Capacity	Weight
12 in (305 mm)	2.13 ft ³ (0.060 m ³)	155 lb (70 kg)
24 in (610 mm)	4.25 ft ³ (0.120 m ³)	218 lb (99 kg)
36 in (914 mm)	6.60 ft ³ (0.186 m ³)	290 lb (132 kg)



NOTE: All specifications are stated in accordance with SAE Standards or Recommended Practices, where applicable.

NOTE: All engines meet current EPA emissions requirements.

IMPORTANT: Case Construction Inc. reserves the right to change these specifications without notice and without incurring any obligation relating to such change. Case Construction Inc. does not warrant the safety or reliability of attachments from other manufacturers.

CASE is a trademark registered in the United States and many other countries, owned by or licensed to CNH Industrial N.V., its subsidiaries or affiliates. CNH Industrial Capital is a trademark in the United States and many other countries, owned by or licensed to CNH Industrial N.V., its subsidiaries or affiliates.



www.casece.com

Form No. CCE201409CX36B
Replaces Form No. CCE201212CX36B

Printed in U.S.A.
CX36B • Page 6 of 6

© 2014 CNH Industrial America LLC
All Rights Reserved



All Case construction equipment is biodiesel ready.